

3D Print

Detail Model

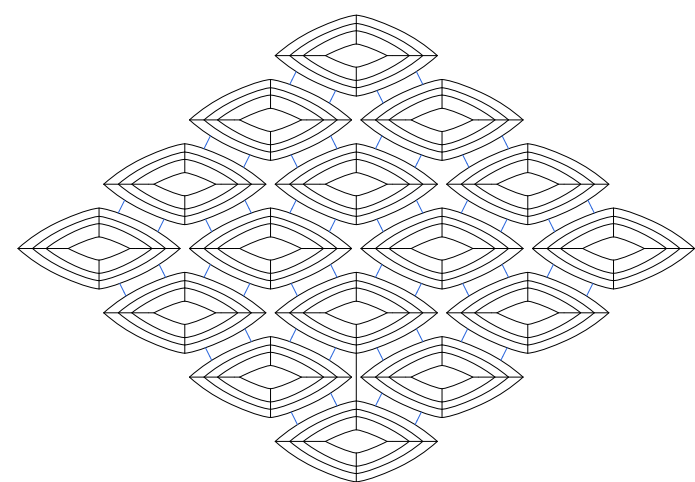

Plan Drawing

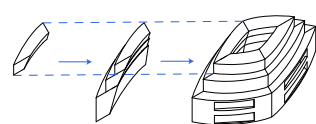
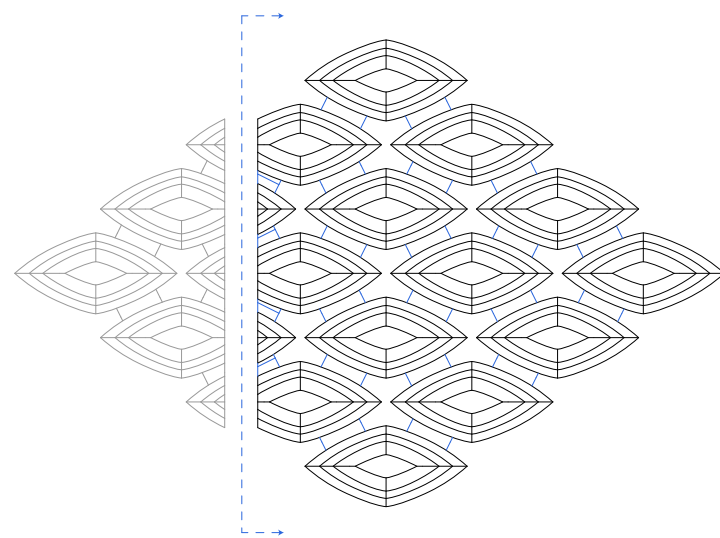

Section Cut

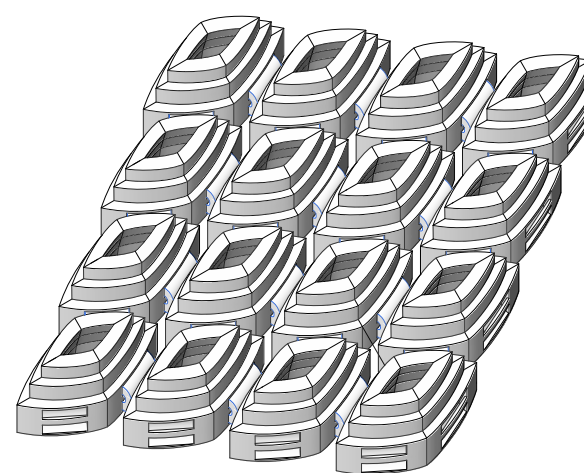

Axon

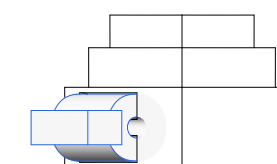

Kinetic Part

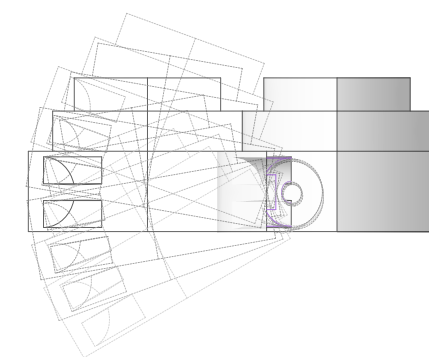

Movement

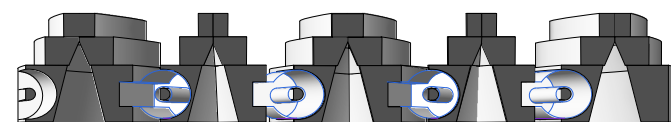

Final Model

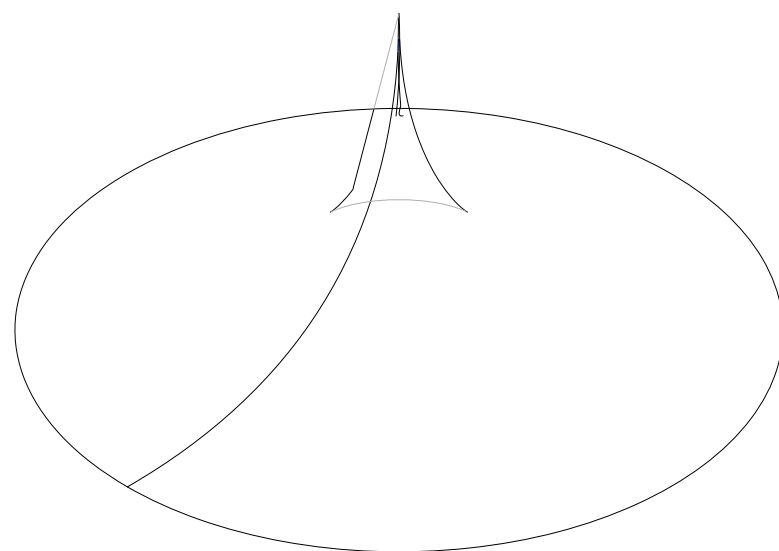

Vault Shape

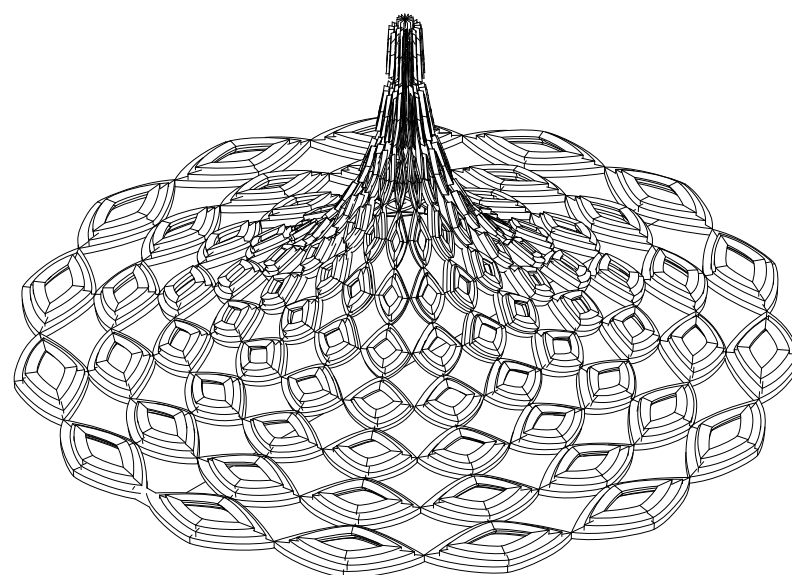

Pattern Arrayed

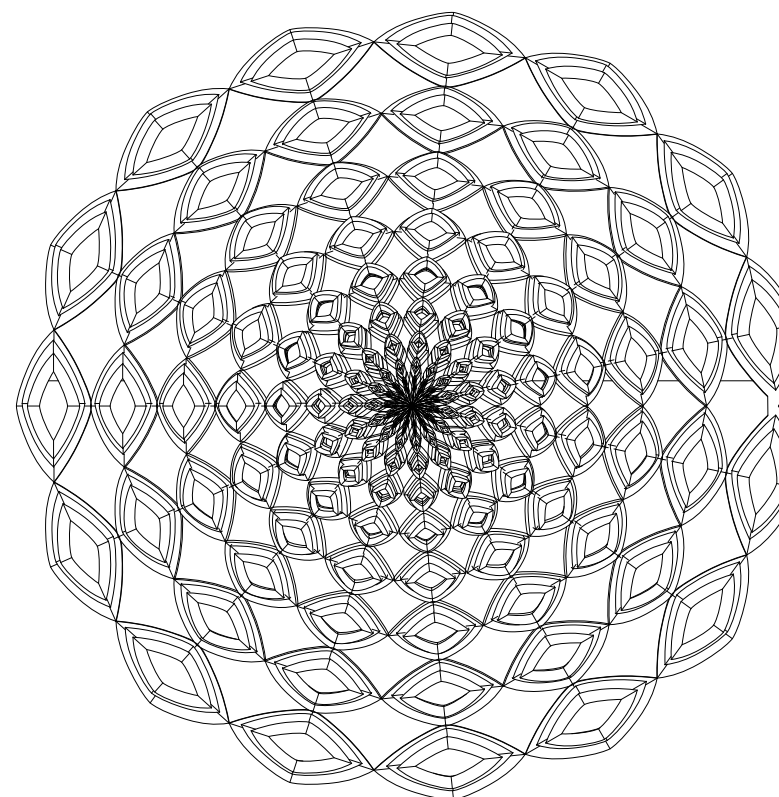

Plan Drawing

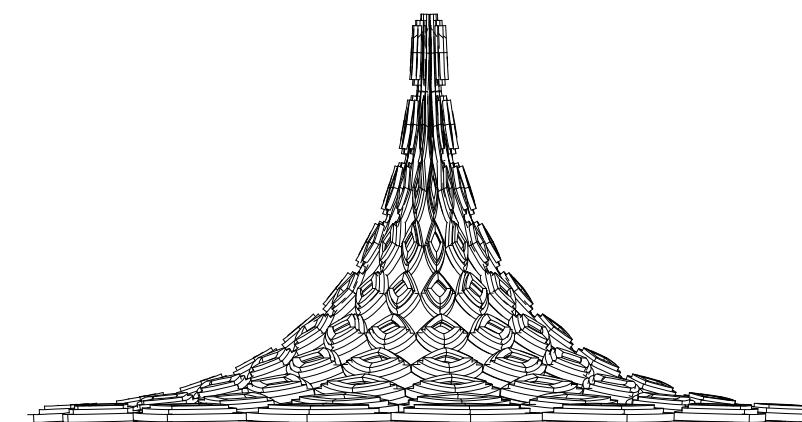

Side Elevation